

2-STAR SKG - SIDE-HUNG SYSTEMS

SKG - FUTURA 3D 130 HINGES AND ARMS

Functions

Futura 3D 130 tilt-and-turn hinge set (upper and lower) and arm.

Technical Features

Hinges: hinge set (upper and lower), completely pre-assembled and ready to be installed on the profile.

Arms: allow tilt-and-turn opening in conjunction with tilt-and-turn hinges and mechanisms.

Materials

Hinges:

- Body of hinges in extruded aluminium and brass
- Supports in zamak with GS Silver Plus finish (up to 500 h corrosion resistance)
- Pins, screws and grub screws in stainless steel

Arms:

- Body, fixing block and slider in zamak with GS Silver Plus finish (up to 500 h corrosion resistance)
- Rod, connecting bracket, grub screws and screws in stainless steel
- Stop disk in polyamide

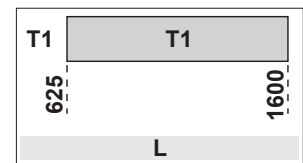
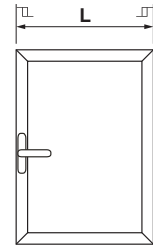

04711

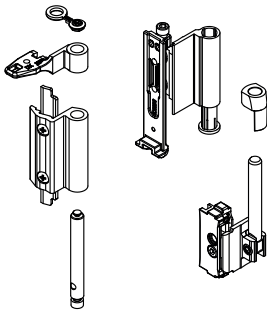

04284

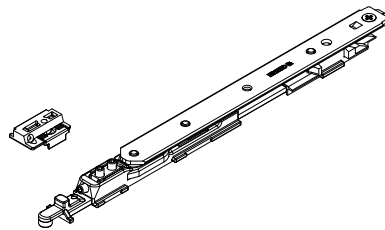

Sash opening

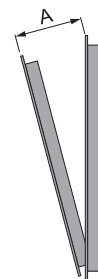

Item code	Description	PROFILE CROSS - SECTION	Base Raw	Anodised Elox	Painted	Trend/Gold Brass	Pieces per pack
04711	HINGE T/T FUTURA 130	C001-C002-C005-C006	X		X	X	10

Item code	Description	PROFILE CROSS - SECTION	A (mm)	Base Raw	Anodised Elox	Painted	Trend/Gold Brass	Pieces per pack
04284	ARM T1 130 WITH MICROVENTILATION	C001-C002-C003-C004-C005-C006-C013-C014-C015-C016-C017	120					10

SKG - FUTURA 3D 130 HINGES AND ARMS

Functions

Futura 3D 130 tilt-and-turn hinge set (upper and lower) and arm.

Technical Features

Hinges: hinge set (upper and lower), completely pre-assembled and ready to be installed on the profile.

Arms: allow tilt-and-turn opening in conjunction with tilt-and-turn hinges and mechanisms.

Materials

Hinges:

- Body of hinges in extruded aluminium and brass
- Supports in zamak with GS Silver Plus finish (up to 500 h corrosion resistance)
- Pins, screws and grub screws in stainless steel

Arms:

- Body, fixing block and slider in zamak with GS Silver Plus finish (up to 500 h corrosion resistance)
- Rod, connecting bracket, grub screws and screws in stainless steel
- Stop disk in polyamide

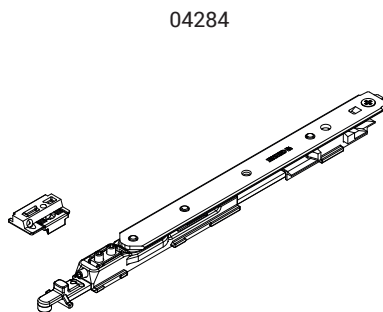
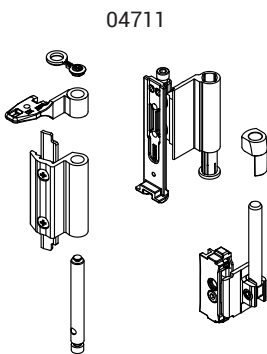
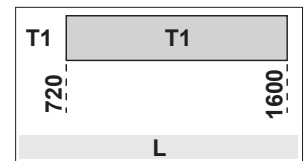
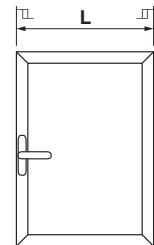

Sash opening

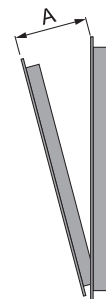

Item code	Description	PROFILE CROSS - SECTION	Base Raw	Anodised Elox	Painted	Trend/Gold Brass	Pieces per pack
04711	HINGE T/T FUTURA 130	C001-C002-C005-C006	X		X	X	10

Item code	Description	PROFILE CROSS - SECTION	A (mm)	Base Raw	Anodised Elox	Painted	Trend/Gold Brass	Pieces per pack
04284	ARM T1 130 WITH MICROVENTILATION	C001-C002-C003-C004-C005-C006-C013-C014-C015-C016-C017	120					10

